

FREESKY[®]
go anywhere

 <https://www.freeskycycle.com>



FREESKY[®]
go anywhere

USER MANUAL



26" Swift Horse Pro ELECTRIC BIKE

YANSAN Technology Co., LTD

Contact us if you experience issues relating to riding Maintenance and safety, or errors/faults with your FREESKY e-bike.

 [https:// www.freeskycycle.com](https://www.freeskycycle.com)

 Amazon& Walmart :support@freeskycycle.com

 Official Website: service@freeskycycle.com

 <https://www.youtube.com/@freeskyebike>

 <https://www.facebook.com/groups/freeskyebike>

Please register your Freesky Ebike warranty upon receiving the bike. Registering your warranty is crucial for accessing superior customer service and support. Follow this link to register:
<https://www.freeskycycle.com/pages/register-your-bike>

Thank You for Choosing a Freesky E-bike!

We are delighted to present you with a high-quality product designed to provide years of pleasure. Kindly review this manual thoroughly before assembling and riding your E-bike.

Should you have any questions after reading this manual, please reach out to us via email or give us a call.

Take Down Your Serial Numbers Here!

Bike frame serial number

Motor serial number

Display serial number

Please note that the Freesky E-bike is now available through various sales channels. For the fastest assistance, email us with your purchase date and order ID. You can also call us if necessary.

Order ID: Locate this in the order history of the account used for the purchase.

You can find your Ebike's serial number on the frame, typically located near the bottom of the head tube. This unique code helps us manage warranty issues, identify the model and year of manufacture, and handle theft claims if needed.



1. The serial number is usually on the motor, starting from the left side (brake disc side).
2. You can find the display serial number on the back of the display.
3. The head tube also has an engraved serial number.

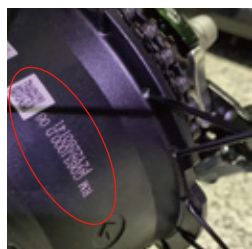

TABLE OF CONTENTS

BEFORE YOUR FIRST RIDE	5
WHAT'S IN THE BOX	6
HOW TO TURN ON THE BATTERY	7
CHARGE THE BATTERY	9
PRODUCT OVERVIEW	11
ASSEMBLY	12
START-UP PROCEDURE	20
DISPLAY	21
SAFETY TIPS	25
PRE-RIDE SAFETY CHECKLIST	28
TIRE INFLATION AND REPLACEMENT	30
TROUBLESHOOTING	31
SPECIFICATIONS	32
WARRANTY	33
DISCLAIMER	35
REFUND POLICY	35
IMPORTANCE	38

Before your first ride

Your First Ride

Exercise extreme caution when taking your e-bike for the first time, as it can accelerate much faster than a regular bicycle when in power-assisted mode. Start by riding in a spacious area to give yourself plenty of room. Avoid pedaling hard immediately upon mounting the e-bike, as the pedal-assist mode will cause a rapid increase in speed that might catch you off guard. With a bit of practice, you'll become accustomed to and enjoy the benefits of the pedal-assisted function.

Operating Instructions

Read This First: Safety and Compliance with the Law Before operating your bike, ensure that it has been assembled correctly according to the provided assembly video, that all components are securely fastened, and a certified, reputable mechanic has inspected the assembly. Once you've read this entire manual, you can turn on the bike and select a pedal assist level by following the steps below:

When you strap on your helmet and go for your first ride, choose an area free from cars, other cyclists, obstacles, or hazards to get familiar with your electric bike's controls, features, and performance.

With the proper safety gear and knowledge, you are ready to ride. On flat terrain, in a low gear (1 or 2), and using rear-wheel drive only, most riders can begin pedaling with pedal assist set to level 0 or 1. You can also use the throttle to accelerate and maintain your preferred speed.

Recommended Rider Size

To ensure the safe operation of the bike, it is essential to understand how to use it properly and adhere to all local traffic, bicycle laws, and

regulations. Riders must be at least 18 years old. It is your responsibility to determine if you can ride the bike safely.

What's in the Box

 <p>1x User Manual</p>	 <p>2x Pedals</p>	 <p>Headlight</p>
 <p>1x Front Wheel</p>	 <p>1x Saddle</p>	 <p>2x Wrench 7x Allen Key Wrench</p>
 <p>2x Keys</p>	 <p>1x Charger</p>	 <p>1x Electric Bike</p>

Carefully inspect the package contents. If any parts are missing or damaged, contact FREESKY customer service immediately and provide your order ID for assistance.

support@freeskycycle.com (Amazon)

service@freeskycycle.com (Freeskycycle website)

It is recommended to retain the original packaging for a short period of time and keep it as intact as possible

For warranty and returns, you are responsible for providing a new box at your expense if you have discarded the original box in which the product was shipped **PLEASE RETAIN YOUR BIKE BOX** even if it has been damaged in shipping

Riding a bicycle comes with inherent risks, and it is your responsibility to ride safely and within your skill level. Proper assembly is crucial for the safe use of your bike, so if you're unable to follow the assembly instructions provided in this manual, seek professional help.

Before assembling your bike, it's advisable to remove the battery for the following reasons:

- To check if the battery was drained or damaged during transportation.
- To reduce the bike's weight, making it easier to handle during assembly.
- To prevent any potential damage to the battery while assembling.

How to Turn on the Battery

Before using the bike, please turn on the battery first.

Remove the battery:



1. Insert the key and turn counterclockwise to unlock the battery lock to unlock the battery lock.



2. Hold the battery with one hand and push the battery switch upward with the other hand.



3. Turn on the battery switch.



4. When the battery is turned on, the indicator light will light up.

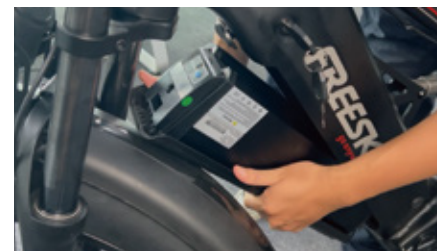

5. After reinstalling the battery, lock the battery and use the bike normally

Battery on Downtube



Battery Charging Port



Battery Power Button



Battery indicator light

Note: In order to protect the battery and increase battery safety, the battery is turned off by default. Please take out the battery and press the switch button before use.

1. Familiarize yourself with the key port and battery power positions before riding the bike. The photo shows the key port aligned in key position 1, in line with the small lock icon. In key position 1, the battery is in the “lock” position, with the battery locked to the frame, and the key removed so the bike is ready to ride.



2. Anytime the battery is in key position 2, (off, unlocked from the frame) the battery must be removed from the bike before moving or riding the bike. Hold the battery and turn the rotary switch to the right to remove the battery.

Charge the Battery

Charge the Battery on the Bike

Before using the electric bike, you must fully charge the battery.



- 1.Remove the rubber cover on the place of charging port of the battery.
- 2.Plug the charger into the battery’s charging port. With the battery on or off the bike, place the charger in a flat, secure place, and connect the DC output plug from the charger to the charging port on the side of the battery.
- 3.Plug the charger into a power outlet, charging should initiate and will be indicated by the LED charge status lights on the charger turning red. Once fully charged, the charging indicator light turning green. Unplug the charger from the wall outlet first and then remove the charger output plug from the battery charging port.
- 4.Unplug the charger from the wall outlet first and then remove the charger output plug from the battery charging port.

Charge Your battery off the bike



1.The battery can be charged separately from the bike. To remove it, securely hold the battery while turning the key to the "unlock" position to prevent it from falling to the ground.



2.Connect the charger to a power outlet, and charging will begin, as shown by the LED status lights on the charger turning red. When fully charged, the indicator light will turn green. First, unplug the charger from the wall outlet, then disconnect the charger output plug from the battery's charging port.

Product Overview



Assembly

Headstock Assembly



1. Lightly fasten the top of the faceplate.



2. Place the handlebar into the locknut on the stem.



3. Center the handlebar and adjust the direction, make sure the handlebar is centered on the stem.



4. Use a wrench to tighten the screw and secure the handlebar stem in place.

Front Wheel Assembly

1. Remove the Red protection piece from the caliper of the brake.
2. Align the disc between the brake caliper as shown in Figure 1.
3. Insert the front wheel in between the front fork on the bike. Be sure the fork is resting on the outside of the axle.

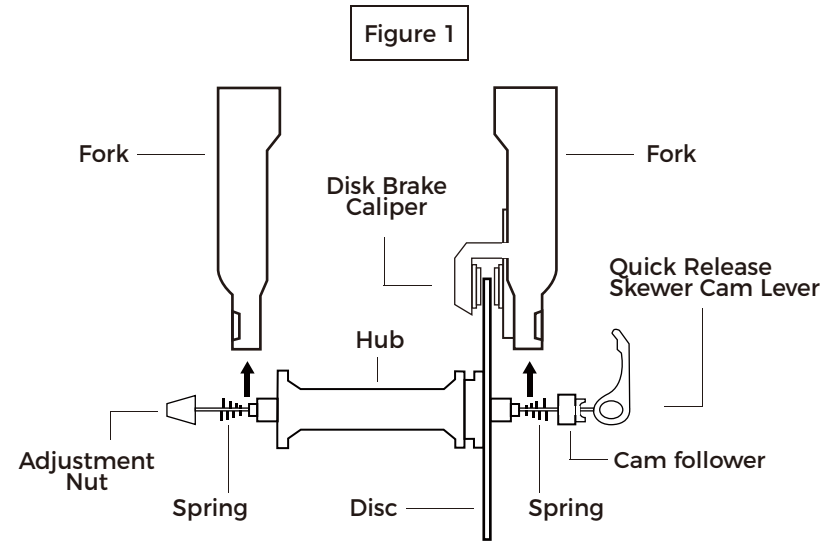

4. Insert the skewer into the wheel axle as seen shown. Keep the spring, cam follower and lever on the LEFT side, nearest the disc brake. Keep the adjustment nut and spring on the RIGHT side. (See Figure 2)

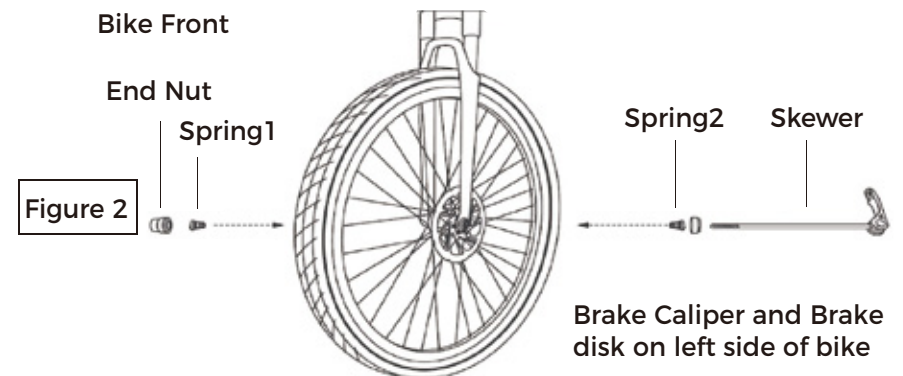

1. Insert the front wheel in between the front fork on the bike. Be sure the fork is resting on the outside of the axle.
2. Align the disk between the brake caliper as shown in Figure 2.
3. Insert the skewer into the wheel axle as seen shown. Keep the spring, cam follower, and lever on the LEFT side, nearest the disk brake. Keep the adjustment nut and spring on the RIGHT side. (See Figure 2)
4. Screw the skewer into the end nut until almost tight.
5. Lift the lever up until parallel with the front fork. You should feel the axle tighten into the front forks. Your front wheel is now installed.

Front light Assembly

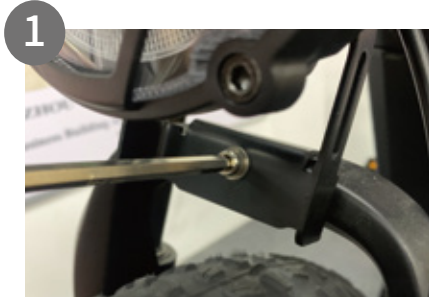

1. Put the headlight on the arch of the fork. Locate the bolt hole.



2. Fix the nut and tighten the bolt.



3. Connect the yellow headlight cable. (Pay attention to the Arrow mark on the cable). Click this link to watch cable connection video: <https://youtu.be/WOrH8cbQgQk>

Saddle Assembly

For better pedaling, safety and overall riding comfort, positioning the seat at the right height is important. The rider's leg length is used to determine the seat's position. When you pedal, your hips should remain level and your legs should be almost fully extended at the bottom of the pedal stroke, but not over-extended. To determine the right seat height, sit on the e-Bike with one pedal at its lowest point and place the ball of your foot on the pedal. Your leg should be almost fully extended (not locked out) with a slight bend at the knee.

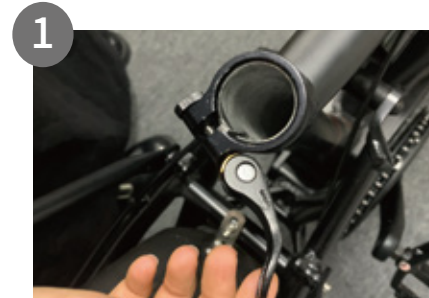

1. Open the quick release lever by swinging the lever open and outward fully.



2. Move the seat up and down by sliding the seatpost in or out of the seat tube. DO NOT raise the seatpost beyond the minimum insertion marking etched into the seatpost tube.



3. Adjust the seat and the head of the seat is parallel with the top tube.



4. Close the quick release lever using your palm or finger.

Saddle Adjustment

Adjusting the Seat Position and Angle

To change the angle and horizontal position of the seat:

(1) Use an Allen wrench to loosen the seat adjustment bolt on the clamp positioned immediately underneath the seat, above the rear wheel. Do not remove the bolt fully.



(2) Move the seat backward or forward and tilt to adjust the angle. A seat position horizontal to flat ground is desirable for most riders. Do not exceed the limit markings on the seat rail, which show the minimum and maximum horizontal movement allowed.

(3) While holding the seat in the desired position, use an Allen wrench to tighten the seat angle adjustment bolt securely to the recommended torque value.



Prior to first use, be sure to tighten the seat clamp via the seat adjustment bolt properly. A loose seat clamp or seatpost adjustment bolt can cause damage to the bike, property, loss of control, a fall, serious injury, or death. Regularly check to make sure that the seat clamp is properly tightened.

Suspension Fork Adjustment

Adjusting the Suspension Fork

The suspension fork can move up and down up to 80mm to cushion bumps in the riding surface, which can make riding on a rough road or trail smoother and more comfortable. Depending on a rider's preference, the suspension fork can be locked out as a rigid fork, which will typically yield higher efficiency while pedaling.

The preload adjustment knob (1), located on the top of the left side of the suspension fork. To soften the ride, subtract resistance by turning the preload adjustment knob counterclockwise, in the direction of the small " - " on the knob. To make the suspension stiffer when going over bumps, add resistance by turning the preload adjustment knob clockwise, in the direction of the small " + " on the knob.



The lockout lever (2), located on top of the right side of the suspension fork, can be turned counterclockwise until it stops to completely lock out the suspension fork's travel. To unlock the lockout lever, turn the knob clockwise until it stops. When the lockout lever is unlocked, resistance can be adjusted by turning.

Pedals Assembly

1. **** Warning ****: Improper installation can lead to damage. Please read the instructions carefully and watch our instructional videos if necessary.

2. Identify the "Left" (L) and "Right" (R) markings on the pedals, as they must be installed on the correct side.

- **** L **** is for the Left Pedal, which should be attached to the Left Crank Arm.

- **** R **** is for the Right Pedal, which should be attached to the Right Crank Arm (chain side).

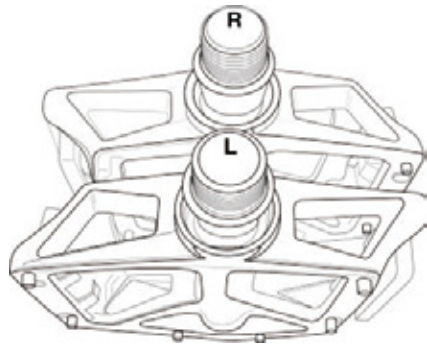



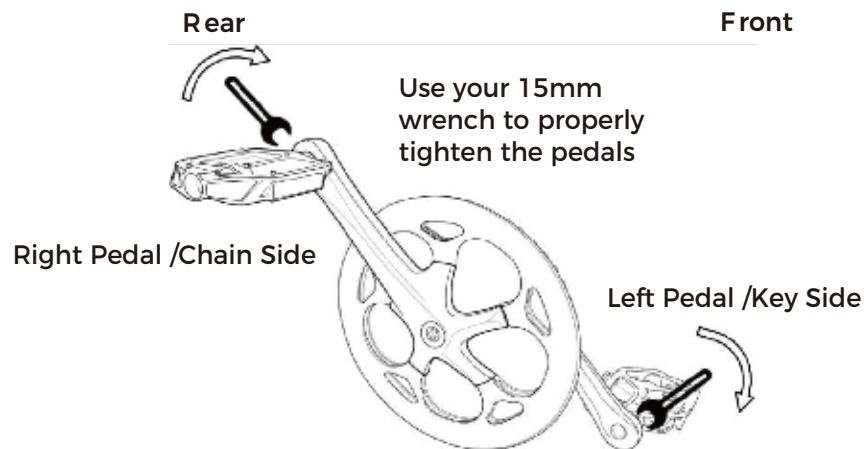

3. While sitting on your bike, the pedals should be installed on the Left and Right sides accordingly.
4. Hold the pedal horizontally and hand-screw it to start the threading. Then, use a 15mm wrench to tighten.
5. Both pedals tighten by turning towards the front of the bike. The left pedal is reverse-threaded to allow for this.
6. Ensure the pedals are very tight and remember to recheck and retighten them after your first few rides.

Both pedals tighten towards the front



Start-Up Procedure

After the bike has been properly assembled according to the assembly video, all components are secured correctly, a certified, reputable mechanic has checked the assembly, and you have read this ensure manual, turn on the bike and select a pedal assist level following the steps below:

1. Turn on the bike: First, take out the battery and press the switch button  on the battery. Then, use NFC to swipe the screen, or hold the power button and then enter the password: 212 to turn on the bike.
2. Turn on the front light if needed or desired. Once the battery is on, short press  button.
3. Select the desired level of pedal assistance (PAS) between level 0 through 5 using the  and  on the display controller. Level 1 corresponds to the lowest level of pedal assistance, and level 5 corresponds to the highest level of pedal assistance. Level 0 indicates pedal assistance is inactive. Start in PAS level 0 or 1 and adjust from there.
4. Begin riding carefully. With the proper safety gear and rider knowledge, you may now operate your bike. On a flat surface, in a low gear (1 or 2), most riders should be able to begin pedaling the bike with pedal assist level 0 or 1. You may also use the throttle to accelerate and maintain your desired speed.
5. The throttle is used by slowly and carefully rotating the throttle backward toward the rider. Do not use the throttle unless you are on the bike.



Do not use the throttle while dismounted. Avoid accidental application of the throttle while dismounted; anytime you are moving the bike while dismounted, ensure the bike is powered off to prevent accidental application of the throttle.

Display

I. Overview

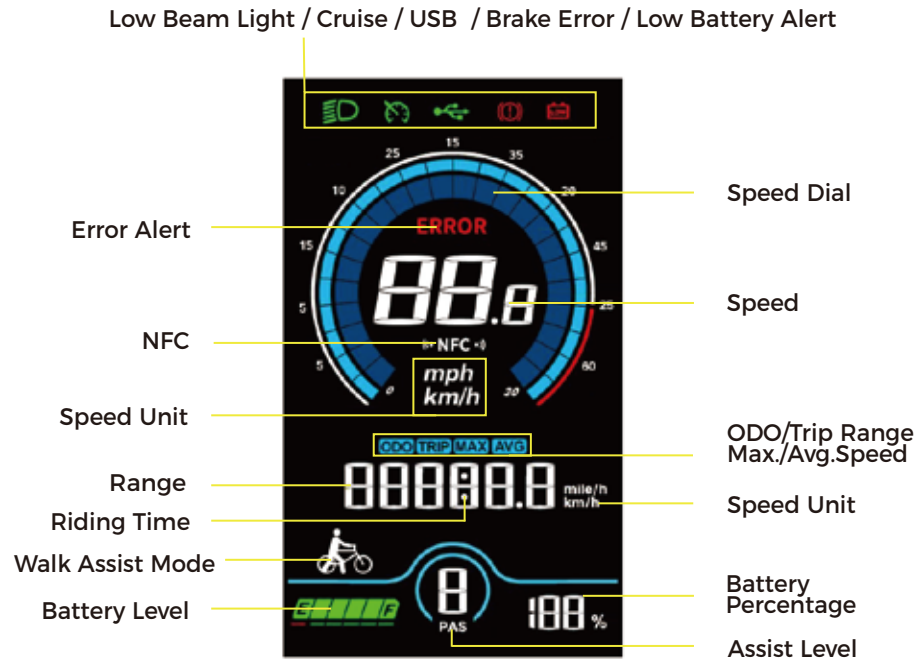

1.Specifications

- Working Voltage: DC 24V/36V/48V/60V/72V
- Working Voltage: DC 24V/36V/48V/60V/72V
- Rated Working Current: 12mA
- Leakage current: <1uA
- Screen Size: 4.0"LCD
- Communication Type: UART (by default) / CAN (optional)
- Working Temperature: -20°C ~ 60°C

- Storage Temperature: -30°C ~ 70°C
- Waterproof Rating: IP66

2. Function

How to turn on the bike:

1. First take out the battery and press the switch button on the battery.
2. Use NFC to swipe the card or enter the password: 1212

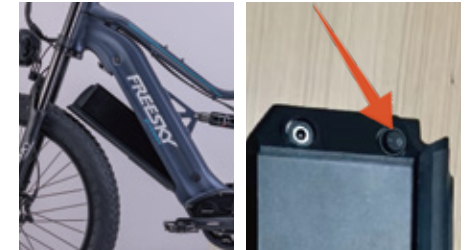

- System unit switch (km/h or mph)
- Assist Level Control and Display
- Battery indication: battery level percentage, low voltage indication
- Speed display: (in km/h or mph) real-time speed (SPEED),
- max speed (MAX), average speed (AVG)
- Distance: single-trip distance (TRIP), total travel distance (ODO)
- Walk assist mode
- Front light indication: front light status supported by controller.
- Error code indication
- Riding Info: Braking Status, Front Light Status, Cruise, Low Voltage.

II. Operation

1. Display Interface

1.1 Riding Interface

- Status: Real-time Riding Status: Front Light, Brake, Low Voltage, Turning, Cruise, Drive Status, etc.
- Battery Status: Residual Battery Percentage
- Multi-Function Section: ODO (total range), TRIP (single ride range), MAX (max. speed), AVG (average speed), TIME (riding time), VOL (battery voltage), Wh (motor power), CUR (current), etc.

2 Error Interface

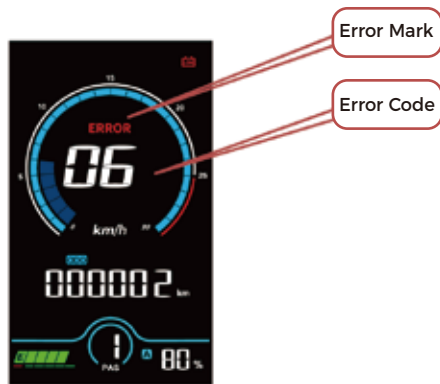





In the above interface: Error Indicator: ERROR, Error Code: 06

3. Key Pad



✚ There are 5 keys on the keypad, in the following instructions:

-  is called On/Off Key;
-  is called Minus/Walk Assist Key;
-  is called Light Key;
-  is called Info Key

4. Key Operation

Key operation guide as follows:

Press and Hold: means press and hold the key(s) for more than 2s.

Press: means press the key(s) for less than 0.5s.

Double Tap: means double tap the key(s) within 0.3s

4.1 On/Off

Turn on the Display: When the display is off, press and hold the On/Off Key to turn on the display, it will show boot interface and then enter riding interface. (If boot password is activated, enter the boot password at start).

Turn off the Display: When the display is on, press and hold the On/Off Key, the display will be turned off. If no operation is engaged for 10min (0km/h), the display will be auto-off. Auto-off time can be set in the Settings.

4.2 Assist Level

Press the Plus Key or Minus/Walk Assist Key to switch assist levels. There are 5 levels by default: 0/1/2/3/4/5. 0 means no assist power.

4.3 Toggle Displays

When the display is on, press the Info Key to toggle among ODO (total range), Trip (single trip range), TIME (riding time) etc.

4.4 Light On/Off

Turn on the Front Light: when the front light is off, press the Light Key to turn it on, and the light icon will be shown on the riding interface (to remove this functions, please reconfigure the controller).

Turn off the Front Light: when the front light is on, press the Light Key to turn it off, and the light icon will be off on the riding interface.

4.5 Walk Assist Mode

Engage Walk Assist Mode: On the riding interface, press and hold the Minus/Walk Assist Key to enter walk assist mode. Hold the Minus/Walk Assist Key to engage walk assist mode, the walk mode icon will be shown on the riding interface, the real-time speed will be shown in the speed section.

SAFETY TIPS

We Recommend The Following Safety-related Procedures:

- **** Wear a Helmet ****: Always wear a helmet for safety.
- **** Ride in Control ****: Maintain control of your bike at all times.
- **** Use Lights and Reflective Gear ****: Equip your bike with lights and wear reflective gear in low-light conditions.
- **** Inspect Your Bike Regularly ****: Check your bike frequently, especially the brakes.
- **** Seek Maintenance ****: If you notice any changes in bike performance, have it checked by a professional.
- **** Know and Follow Road Rules ****: Familiarize yourself with and adhere to all road rules for cyclists.
- **** Ride Defensively ****: Be aware that you may not be as visible to motorists, pedestrians, or other cyclists as you think. Always be prepared to stop or take evasive action. The electric motor may make you travel faster than drivers expect.
- **** Avoid Road Hazards ****: Steer clear of potholes, drain grates, railroad tracks, loose road material, and other potential hazards.
- **** Use Both Brakes ****: For optimal stopping performance, use both the front and rear brakes. Relying only on the rear brake will significantly increase your stopping distance.

Cycling on sidewalks or pavements can increase the risk of accidents for both you and pedestrians. E-bikes can travel faster than traditional bicycles, making this risk even higher.

Be cautious of all road users. According to AXcess (source), drivers may not always recognize how fast you are traveling and might assume you're moving much slower than you are. To minimize the risk of accidents, always yield to cars and avoid rushing. Exercise patience and stay alert, especially at intersections and turns.

Guide to Cycling At Night

Use Lights Properly: When riding at night, ensure you have lights on both the front and rear of your bike.

For added safety, consider using a clip-on light for your helmet or investing in a helmet with a built-in LED light. Wearing a light vest over your clothing can enhance visibility, allowing drivers to see you from a greater distance and ensuring they pass with sufficient clearance. Always turn on any built-in lights before heading out to ride.

Recommended Service Intervals

Regular inspection and maintenance are key to ensure bikes from Freesky function as intended and to reduce wear and tear on their systems. Recommended service intervals are meant to be used as guidelines. Real-world wear and tear, and the need for service will vary with the condition of use. We generally recommend inspections, service, and necessary replacements be performed at the time or mileage interval that comes first in the following table.

Interval	Inspect	Service	Replace
Weekly, 100-200 miles (160-321 km)	1.Check drivetrain for proper alignment and function (including the chain, freewheel, chainring, and derailleur). 2.Check wheel trueness and for quiet wheel operation (without spoke noise). 3.Check condition of frame for any damage.	1. Clean frame by wiping frame down with damp cloth. 2. Use barrel adjuster(s) to tension derailleur/ brake cables if needed.	1. Replace any components confirmed by Freesky, Product Support or a certified, reputable bike mechanic.
Monthly, 250-750 miles (402-1207km)	1.Check bike is shifting properly, proper derailleur cable tension. 2.Check chain stretch. 3.Check spoke tension. 4.Check accessory mounting (rack mounting bolts, and alignment). 5.Check that the screws are secured	1. Clean and lubricate drivetrain. 2. Check crankset and pedal torque. 3. Clean brake and shift cables. 4. True and tension wheels if any loose spokes are discovered. 5. Balance the battery. 6.Tighten the screws.	1. Replace brake and shift cables if necessary. 2. Replace brake pads if necessary.
Every 6 Months, 750-1250miles (1207-2011km)	1.Inspect drivetrain (chain, chainring, freewheel, and derailleur). 2.Inspect all cables and housings.	1. Standard tune-up by certified, reputable bike mechanic is recommended. 2. Grease bottom bracket.	1. Replace brake pads. 2. Replace tires if necessary. 3. Replace cables and housings if necessary.

Pre-Ride Safety Checklist

Notice: Before every ride, and after every 25-45 miles(40-72 km), we advise you following the pre-ride safety checklist.

Safety Check	
1.Brakes	Ensure front and rear brakes work properly. Check brake pads for wear and ensure they are not overworn. Ensure brake pads are correctly positioned in relation to the rims. Ensure brake levers are lubricated and tightly secured to the handlebar. Test that the brake levers are firm and that the brake is functioning properly.
2.Wheels and Tires	Ensure tires are inflated within the recommended limits posted on the tire sidewalls and hold air. Ensure tires have good tread, have no bulges or excessive wear, and are free from any other damage. Ensure rims run true and have no obvious wobbles, dents, or kinks. Ensure all wheel spokes are tight and not broken. Check axle nuts and front wheel quick release to ensure they are tight. Ensure the locking lever on the quick release skewer is correctly tensioned, fully closed, and secured.
3.Steering	Ensure the handlebar and stem are correctly adjusted, tightened, and allow proper steering. Perform a handlebar twist test to ensure the stem clamp bolt security. Ensure the handlebar is set correctly in relation to the fork and the direction of travel.
4.Chain	Ensure the chain is clean, oiled, and runs smoothly. Extra care is required in wet, salty/otherwise corrosive, or dusty conditions.
5.Bearings	Ensure all bearings are lubricated, run freely, and display no excess movement, grinding, or rattling. Check headset, wheel bearings, pedal bearings, and bottom bracket bearings.
6.Cranks and Pedals	Ensure pedals are securely tightened to the cranks. Ensure the cranks are securely tightened and are not bent.

7.Derailleur and Mechanical Cables	Check that the derailleur is adjusted and functioning properly. Ensure the shifter and brake levers are attached to the handlebar securely. Ensure all shifter and brake cables are properly lubricated.
8.Frame, Fork, and Seat	Check that the frame and fork are not bent or broken. If either frame or fork are bent or broken, they should be replaced. Check that the seat is adjusted properly, and seatpost quick release lever is securely tightened.
9.Motor Drive Assembly and Throttle	Ensure hub motor is spinning smoothly and motor bearings are in good working order. Ensure all power cables running to hub motor are secured and undamaged. Make sure the hub motor axle bolts are secured and the torque arm, torque arm bolt, and torque washers are in place
10.Battery	Ensure battery is charged before use. Ensure there is no damage to battery. Lock battery to frame and ensure that it is secured. Charge and store bike and battery in a dry location, between 50 °F - 77 °F (10 °C - 25 °C). Let bike dry completely before using again.
11.Electrical Cables	Look over connectors to make sure they are fully seated and free from debris or moisture. Check cables and cable housing for obvious signs of damage. Ensure front light is functioning, adjusted properly, and unobstructed.
12.Accessories	Ensure all reflectors are properly fitted and not obscured. Ensure all other fittings on bike are properly secured and functioning. Inspect helmet and other safety gear for signs of damage. Ensure rider is wearing a helmet and other required riding safety gear. Ensure mounting hardware is properly secured if fitted with a front rack, rear rack, basket, etc. Ensure the taillight and taillight power wire are properly secured if fitted with rear rack. Ensure the fender mounting hardware is properly secured if fitted with fenders. Ensure there are no cracks or holes in fenders. If installed, ensure the optional rear wheel lock is secured in the unlocked position and the key is removed before every ride.

 After the initial break-in period of 50-100 miles (80-160 km), your cables, spokes, and chain may stretch, and bolted connections can loosen. It is essential to have a certified, reputable bike mechanic perform a tune-up after this break-in period, which can vary based on factors like total weight, riding style, and terrain. Regular inspections and tune-ups are crucial to ensuring your bike stays safe and enjoyable to ride.

Tire Inflation and Replacement

The SWIFT HORSE pro employs 26"x4"rubber tires with inner tubes. The tires are designed for durability and safety for regular cycling activities and need to be checked before each use for proper inflation and condition. Proper inflation, care, and timely replacement will help ensure that your bike's operational characteristics will be maintained, and unsafe conditions avoided.

Freesky recommends 16-20 PSI for the stock tires. Always stay within the manufacturer's recommended air pressure range as listed on the tire sidewall.



It is critically important that proper air pressure is always maintained in pneumatic tires. Do not underinflate or overinflate your tires. Low pressure may result in loss of control, and overinflated tires may burst. Failure to always maintain the air pressure rating indicated on pneumatic tires may result in tire and/or wheel failure.



Inflate your tires from a regulated air source with an available pressure gauge. Inflating your tires from an unregulated air source could overinflate them, resulting in a burst tire.

Even tires equipped with built-in, flat-preventative tire liners, like those that come with bikes from Freesky, can and do get flats from punctures, pinches, impact, and other causes. When tire wear becomes evident or a flat tire is discovered, tires and/or tubes must be replaced before operating the bike or injury to operators and/or damage to your bike from Freesky could occur.



When changing a tire or tube, ensure that all air pressure has been removed from the inner tube prior to removing the tire from the rim. Failure to remove all air pressure from the inner tube could result in serious injury.



Using aftermarket tires or inner tubes, not provided by Freesky may void your warranty, create an unsafe riding condition, or damage your bike. If required by law, ensure replacement aftermarket tires have sufficient reflective sidewall striping.

For more information on torn or tube replacement procedures, or questions about tire inflation, contact Freesky after-sale service at support@freeskycycle.com.

Troubleshooting

Symptoms	Possible Causes	Most Common Solutions
The bike does not work	<ol style="list-style-type: none"> 1. Insufficient battery power 2. Faulty connections 3. Battery not fully seated in tray 4. Improper turn on sequence 5. Brakes are applied 6. Blown discharge fuse 	<ol style="list-style-type: none"> 1. Charge the battery 2. Clean and repair connectors 3. Install battery correctly 4. Turn on bike with proper sequence. 5. Disengage brakes 6. Replace discharge fuse
Irregular acceleration and/or reduced top speed.	<ol style="list-style-type: none"> 1. Insufficient battery power 2. Loose or damaged throttle 3. Misaligned or damaged magnet ring. 	<ol style="list-style-type: none"> 1. Charge or replace battery 2. Replace throttle 3. Align or replace magnet ring
The motor does not respond when the bike is powered on.	<ol style="list-style-type: none"> 1. Loose wiring 2. Loose or damaged throttle 3. Loose or damaged motor plug wire. 4. Damaged motor 	<ol style="list-style-type: none"> 1. Repair and or reconnect 2. Tighten or replace 3. Secure or replace 4. Repair or replace
Reduced range	<ol style="list-style-type: none"> 1. Low tire pressure 2. Low or faulty battery 3. Driving with too many hills, headwind, braking, and/or excessive load 4. Battery discharged for long period of time without regular charges, aged, damaged, or unbalanced 5. Brakes rubbing 	<ol style="list-style-type: none"> 1. Adjust tire pressure 2. Check connections or charge battery. 3. Assist with pedals or adjust route. 4. Balance the battery; contact Tech. Support if range decline persists. 5. Adjust the brakes
The battery will not charge	<ol style="list-style-type: none"> 1. Charger not well connected 2. Charger damaged 3. Battery damaged 4. Wiring damaged 5. Blown charge fuse 	<ol style="list-style-type: none"> 1. Adjust the connections 2. Replace 3. Replace 4. Repair or replace 5. Replace charge fuse
Wheel or motor makes strange noises	<ol style="list-style-type: none"> 1. Loose or damaged wheel spokes or rim 2. Loose or damaged motor wiring 	<ol style="list-style-type: none"> 1. Tighten, repair, or replace 2. Reconnect or replace motor.

Warranty

The warranty is non-transferable and only applies to the original owner. This warranty gives you specific rights and purchasers may also have other rights, which may vary from state to state. Damage caused by failing to follow instructions in the manual, acts of God, accident, misuse, neglect, abuse, commercial use, alterations, modification, improper assembly, installation of parts or accessories not originally intended or compatible with the Freesky eBike as sold, operator error, water damage, extreme riding, stunt riding, or improper follow-up maintenance is not covered under this warranty.

Warranty parts will only be shipped within the continental United States. Parts covered by the warranty: frame, forks, stem, handlebars, headset, seat post, saddle, brakes (excluding brake pads), lights, bottom bracket, crank set, pedals, rims, wheel hub, freewheel, cassette, derailleur, shifter, motor, throttle, controller, wiring harness, display (excluding damage due to water), kickstand, reflectors, and hardware. The battery warranty does not include damage from power surges, use of 3rd party charger, improper maintenance or other such misuse, normal wear, or water damage (including rust).

Accessories sold on [freeskycycle.com](https://www.freeskycycle.com) are not covered under warranty. Stolen bikes are not covered under warranty.

Necessary precautions must be taken to ensure the bike and battery are not exposed to severe weather conditions. Exposure to very wet, hot, or cold conditions may void the warranty.

Freesky eBikes will replace any parts deemed to have been damaged during shipping. Shipping damage must be reported to Freesky eBikes within 7 days of shipment arrival. This applies to all products, including bikes and accessories. You will NOT be refunded as compensation for your time or efforts replacing damaged parts. Replacement parts will not be sent until photographic evidence has been provided to Freesky eBikes. Freesky eBikes may request additional

documentation (such as video) to assist with accurately diagnosing the problem and processing the warranty claim.

Most warranty parts will be fulfilled in 5 business days after the request is put into our system by a customer service representative. Warranty parts will be sent from our American warehouse if stock is available, or we will ship from China factory, where the shipping time takes around 2 weeks. Warranty parts will not be expedited. Items including the chain, tires, wheels, rims, tubes, battery handle, brake rotors, brake pads, cables and housings, grips, and spokes are considered wear items. These items wear down with normal use and are not covered under warranty. You are responsible for replacing and maintaining these wear items. Any unauthorized alterations or repairs are not covered and may void this warranty.

For warranty services, please contact Freesky ebike's online support by email at support@freeskycycle.com. Bikes or parts returned without proper documentation may result in delayed service or denied warranty coverage. Warranty return shipping costs along with duties and taxes are the responsibility of the claimant. All unauthorized returns will be refused.

Note that your insurance policies may not provide coverage for accidents involving Freesky eBikes. To determine if coverage is provided, you should contact your insurance company or agent.

Damage as a result of an accident is not covered under this warranty, and Freesky eBikes is not responsible for repair or replacement of damaged bikes or parts.

Freesky eBikes reserves the right to change its warranty at any time and without notice.

Any action, lawsuit or other proceeding, under this warranty or otherwise related to the bike must be commenced within ninety (90) days after expiration of the one-year warranty period.

Bike Performance Disclaimer

The listed range and top speed of the bike are estimates, not guarantees of performance. Various factors will affect actual performance, including rider weight, cargo weight, shape (which affects drag), terrain, tire pressure, brake adjustment, throttle & PAS usage, pedal power, battery charge level, ambient temperature, and wind conditions. It is possible to achieve different ranges and top speeds than the listed estimates.

To maximize the range per battery charge:

- Ride at a lower PAS level.
- Use lower PAS levels and pedal when climbing hills.
- Pedal when starting from a standstill.

Refund Policy

PARTS DAMAGED:

Ebikes from Freesky may experience some damage because of long-time transportation, send us pictures immediately after you get the items, After approval, we will send you replacement parts or a partial refund upon agreement.

EBIKE RETURNS:

Ebikes from Freesky are under a 15-day return policy, which means you have 15 days after receiving your item to request a return. To return an e-bike that is not defective or damaged please contact the customer service team within 15 days.

We do not provide product returns service after 15 days, as same as refund.

Please make sure the following if you need to return the bike:

1. The mileage on the LCD screen of the e-bike must be less than 10 miles.
2. There should be no wear, dirt, scratches, fragrances, or any other signs of use.
3. All items (chargers, keys, hardware, etc.) received by the customer must be included in the original packaging (all cardboard and foam) and in the same condition.

You will be responsible for paying the shipping costs for returning your item under this condition :

Original and return shipping costs are nonrefundable, and we do charge a restocking fee of up to 25% of order value for the return, Return shipping fees may vary depending upon the chosen freight carrier, Customers are responsible for arranging the return shipping and paying any fees.

We recommend using a trackable shipping service and purchasing shipping insurance. Before a return is sent, the customer must have written approval of said return from Freesky. If a customer sends a return without the written consent of Freesky, a refund will not be issued and the customer will have to pay for shipping to get the item returned, or sacrifice the item. Once we receive the item, we will conduct a detailed inspection of the package, then we will either replace the item or give you a partial refund according to the actual condition of the item we received. This will be issued in 2-5 business days, for an e-bike that has been delivered for more than 15 days or used for more than 10 miles.

If there is any problem, we do not accept returns anymore, only repairs and replacements are allowed.

LATE OR MISSING REFUNDS

If you haven't received a refund after 5 business days of approval, please check your bank account again and contact your credit card company/ bank as it may take some time before your refund is officially posted, There is often some processing time before a refund is posted If you've done all of this and you still

have not received your refund, please contact us at: service @freeskycycle.com.

COMPLIANCE WITH THE LAW

Riders are responsible for adhering to all local, state, and federal laws and regulations regarding the operation of electric bicycles. It is crucial to familiarize yourself with and follow applicable laws, including those related to helmet use, speed limits, and where electric bikes are permitted. Failure to comply with the law may result in fines, legal consequences, or increased risk of injury. Freesky is not liable for any legal issues or penalties incurred due to non-compliance with regulations.

OBSERVE LAWS REGARDING THE USE OF BATTERY-OPERATED BICYCLES

Your e-bike has been designed and manufactured to meet safety standards as a battery-operated bicycle. However, laws regulating the use of battery-operated bicycles on public roads, parks, and other open areas may vary by state and locality. It is important to consult with your local authorities before riding your e-bike in public areas to ensure compliance with all applicable regulations.

Observe Laws Regarding the Use of Bicycles

Please be aware that all laws governing the use of bicycles in public areas, including those requiring helmets and infant seats, also apply to e-bikes. It is important to check with your local authority to understand any specific restrictions or regulations that may be in place for electric bicycles.

The Lithium-Ion Battery of Your E-Bike

Your e-bike features advanced lithium-ion battery technology, which is significantly lighter compared to older lead- or nickel-based batteries used in some previous models.

Your First Ride

Exercise extreme caution when taking your e-bike for the first time, as it can accelerate much faster than a regular bicycle when in power-assisted mode. Start by riding in a spacious area to give yourself plenty of room. Avoid pedaling hard immediately upon mounting the e-bike, as the pedal-assist mode will cause a rapid increase in speed that might catch you off guard. With a bit of practice, you'll become accustomed to and enjoy the benefits of the pedal-assisted function.

IMPORTANCE

Please review this owner's manual thoroughly before operating your SWIFT HORSE PRO X6E to fully understand the proper use of the bike's controls, features, capabilities, and limitations. While this handbook

offers safety tips for riding, it does not cover the techniques and skills required to ride an electric bicycle safely. This owner's manual provides instructions for assembly and maintenance tasks that may need to be done regularly to keep your SWIFT HORSE PRO X6E in safe and working condition. Never attempt to perform tasks on your bike beyond what is outlined in this manual. It is not intended as a complete guide for usage, service, repair, or maintenance. Do NOT ride your SWIFT HORSE PRO X6E if it has been improperly assembled. An Ebike specialist or professional cycle mechanic should handle any maintenance outside the scope of this manual. Riding an improperly assembled bike can endanger your safety and that of others.

Liability Disclaimer

Riding any type of bicycle involves inherent risks and potential dangers that cannot be foreseen or avoided, and these risks may lead to serious accidents, injury, or even death. It is the rider's sole responsibility to become fully educated and adequately prepared to ride safely. Once the bike is in your possession, Freesky highly recommends and urges all customers to have a certified, reputable bicycle mechanic perform a complete inspection of all components to ensure safe operation. Before each ride, thoroughly inspect your bicycle to confirm that all parts are securely fastened and properly adjusted.

Freesky is not liable under any circumstances for damage caused by defective, damaged, or improperly secured parts. This includes but is not limited to, damage to personal property, personal injury, or death.

Disclaimer: Riders must be 18 years of age or older to operate this bicycle.